

Paper published in Renewable & Sustainable Energy Reviews

**The Economic Viability of Battery Storage
for Residential Solar Photovoltaic Systems –
A Review and a Simulation Model**

Joern Hoppmann^{1,2*}, Jonas Volland¹, Tobias S. Schmidt¹, Volker H. Hoffmann¹

¹ ETH Zurich

Department of Management, Technology, and Economics
Weinbergstrasse 56/58, 8092 Zurich, Switzerland

² Harvard University

Energy Technology Innovation Policy Group
79 John F. Kennedy Street, Cambridge, MA 02138

* Corresponding author

Phone: +41-44 632 82 03

Fax: +41-44 632 10 45

E-mail: jhoppmann@ethz.ch

Please cite as: Hoppmann J., Volland J., Schmidt T.S., Hoffmann V.H. (2014):
"The Economic Viability of Battery Storage for Residential Solar Photovoltaic Systems - A Review
and a Simulation Model", Renewable and Sustainable Energy Reviews 39, 1101–1118.

Abstract

Battery storage is generally considered an effective means for reducing the intermittency of electricity generated by solar photovoltaic (PV) systems. However, currently it remains unclear when and under which conditions battery storage can be profitably operated in residential PV systems without policy support. Based on a review of previous studies that have examined the economics of integrated PV-battery systems, in this paper we devise a simulation model that investigates the economic viability of battery storage for residential PV in Germany under eight different electricity price scenarios from 2013 to 2022. In contrast to previous forward-looking studies, we assume that no premium is paid for solar photovoltaic power and/or self-consumed electricity. Additionally, we run the model with a large number of different PV and storage capacities to determine the economically optimal configuration in terms of system size. We find that already in 2013 investments in storage solutions were economically viable for small PV systems. Given the assumptions of our model, the optimal size of both residential PV systems and battery storage rises significantly in the future. Higher electricity retail prices, lower electricity wholesale prices or limited access to the electricity wholesale market add to the profitability of storage. We conclude that additional policy incentives to foster investments in battery storage for residential PV in Germany will only be necessary in the short run. At the same time, the impending profitability of integrated PV-storage systems is likely to further spur the ongoing trend toward distributed electricity generation with major implications for the electricity sector.

Keywords: Solar Photovoltaic Power, Solar Energy, Battery Storage, Distributed Electricity Generation, Techno-Economic Model, Simulation, Electricity Price

1 Introduction

Renewable energy technologies are expected to play a major role in mitigating pressing societal challenges such as climate change and resource depletion, while contributing to domestic energy security. Among the many options available, solar photovoltaic (PV) power has been found to have a particularly large physical potential for electricity generation [1]. However, three important barriers to a more widespread use of solar PV are that electricity generation from this source is limited to daytimes, depends on local weather conditions and fluctuates strongly over the year [2]. As a consequence, there are often considerable gaps between electricity consumption and the electricity supply of PV plants. With an increasing deployment of PV, such demand-supply mismatches pose an increasing threat to the stability of the electricity system [3].

An effective means for reducing (and eventually eliminating) the mismatches between electricity demand and electricity supply by intermittent energy sources are storage technologies. Responding to the need for steadier electricity supply, several companies in the PV industry have started to develop and sell storage solutions based on battery technologies [4]. Yet, while the possibility of shifting the supply of electricity to different times enhances the value of the electricity produced, adding storage technologies to a PV system also raises the overall investment cost to be borne by plant operators. First countries, like Germany, have therefore announced programs that subsidize the use of storage technologies for residential PV [5]. Considering the falling costs for both PV and battery technologies, however, it remains controversially discussed whether and for how long these subsidies are necessary to drive the deployment of storage technologies.

Currently, the academic literature provides little guidance as to when the advantages of combining PV systems with storage can be expected to justify the extra expenses. Existing studies on integrated PV-storage systems mostly focus on the additional costs rather than the added economic value from storage (see section 2). The few studies that investigate profitability of storage for PV typically examine its potential to raise the share of electricity generated by the residential PV system that is consumed by the household (so-called self-consumption). By investing in storage technologies households can leverage the existing spread between wholesale and retail electricity prices by reducing both the volume of electricity that is bought at retail prices and the one to be sold at wholesale prices [6-8]. Yet, while these studies have strongly advanced our knowledge about the role that storage can play for residential PV systems, two main shortcomings remain. First, existing studies examine the economic viability of storage under the assumption of policy support in the form of feed-in tariffs for solar photovoltaic power and/or additional premiums for self-consumed electricity. However, feed-in tariffs in many countries have significantly decreased over the last years and are expected to be phased out in the foreseeable future [9]. Therefore, it seems important to investigate the profitability of storage in an environment without demand-side subsidies for PV and storage technologies. In this case wholesale and retail electricity market price developments will strongly

affect storage profitability. Second, and more importantly, existing forward-looking studies that investigate the profitability of storage for residential PV have usually investigated a limited number of sizes for both the PV system and the battery storage. However, especially under the assumption of no additional policy incentives, the chosen size of the PV system and battery storage strongly affect the economic viability of the integrated PV-battery system. This is because the economic viability of storage is strongly driven by the degree to which electricity produced by the PV system is self-consumed, which in turn is highly sensitive to the aforementioned parameters. As a result, it currently remains unclear when storage investments will be economically viable for a household that optimizes the size of the PV system and the battery storage at the time of investment.

With this paper, we address the two previously mentioned shortcomings by investigating the question *when and under which conditions battery storage will be economically viable in residential PV systems without demand-side subsidies for an economically optimized system configuration*. Building upon a review of existing studies that have examined the economics of integrated PV-storage solutions, we present the outcomes of a techno-economic model that calculates the profitability of storage for distributed PV from 2013 to 2022. To account for uncertainties in the future development of technology costs and electricity prices, we draw on 8 electricity price scenarios and conduct a comprehensive sensitivity analysis. Analyzing the optimal PV system size, the optimal storage size and the profitability of storage under each of these scenarios allows deriving important implications for policy making and the trend toward distributed electricity generation.

The remainder of this paper is structured as follows: Section 2 reviews existing studies that have investigated PV systems with storage solutions and discusses existing shortcomings. Section 3 explains the data and method underlying our techno-economic model, followed by a discussion of the model results in section 4 and their implications in section 5. The paper concludes with a description of the study's limitations, suggestions for future research (section 6) and a brief summary of the main results (section 7).

2 Literature Review

An overview of past studies that have investigated the economics of battery storage in distributed PV systems is given in Table 1.¹ It shows that in recent years a number of articles have been published that examine how different input parameters, such as PV system and storage size, affect specific economic output parameters, e.g. the cost of electricity or the profitability of the integrated PV-battery-system.

¹ The list of publications is limited to original papers dealing with small PV systems (< 15kW) and does not include studies of integrated PV-storage systems in hybrid applications (e.g. in combination with wind power or diesel generators).

Table 1: Overview of studies investigating the economics of battery storage in distributed PV systems

Ref.	Author	PV Technology	Battery Technology	Varied Input Parameters	Econ. Output Parameter	FIT*/SC** premium?	Time of investment
[10]	Arun et al. (2009)	Not specified	Not specified	PV system and storage size	Cost of electricity	No/No	Not spec., one year
[11]	Askari and Ameri (2009)	Not specified	Lead-acid	PV system and storage size	Cost of electricity	No/No	Not spec., one year
[12]	Avril et al. (2010)	Crystalline silicon (poly)	Lead-acid, Nickel Cadmium	Technology cost	Cost of electricity	No/No	2011-2020
[13]	Battke et al. (2014)	Not specified	Lead-acid, lithium-ion, sodium-sulfur, vanadium redox flow	Storage cost, storage roundtrip efficiency, life time and cycle life	Cost of electricity	No/No	2013
[6]	Bost et al. (2011)	Crystalline silicon (mono)	Lithium-Ion	PV system and storage size, technology cost, consumption pattern	Cost of electricity. Grid Parity	Yes/Yes	2010-2020
[7]	Braun et al. (2009)	Crystalline silicon (mono)	Lithium-Ion	Storage size, electricity price, technology cost, FIT degression rate	IRR, payback period	Yes/Yes	2010, 2014
[14]	Celik et al. (2008)	Crystalline silicon (mono)	Lead-acid	PV system size, location	Cost of electricity	No/No	Not spec., one year
[15]	Clastres et al. (2010)	Crystalline silicon (poly)	Not specified	Consumption pattern	Profit	No/No	Not spec., one year
[8]	Colmenar-Santos et al. (2012)	Not specified	Lead-acid	PV system and storage size	IRR, payback period	Yes/No	2011
[16]	Denholm and Margolis (2007)	Not specified	Not specified	PV system and storage size	Cost of electricity	No/No	Not spec., one year
[17]	Jallouli and Krichen (2012)	Not specified	Lead-acid	Storage size	Cost of electricity	No/No	Not spec., one year
[18]	Kaldellis et al. (2009)	Not specified	Lead-acid, sodium-sulfur	PV system size, energy autonomy, solar irradiation, discount rate, investment subsidy, electricity price	Cost of electricity	No/No	Not spec., one year
[19]	Kolhe (2009)	Not specified	Not specified	PV system and storage size, technology cost	Cost of electricity	No/No	Not spec., one year
[20]	Kolhe et al. (2002)	Not specified	Lead-acid	Discount rate, solar irradiation, technology cost, O&M costs	Cost of electricity	No/No	Not spec., one year
[21]	Lazou and Papatoris (2000)	Crystalline silicon (mono)	Lead-acid	Technology cost, location	Cost of electricity	No/No	1998, 2005
[22]	Li et al. (2009)	Crystalline silicon (poly)	Lead-acid	PV system size, technology cost, component efficiency	Cost of electricity	No/No	Not spec., one year
[23]	Liu et al. (2012)	Thin-film	Lead-acid	PV system and storage size, PV panel slope, technology cost and life-time, electricity price	Cost of electricity, net present cost	Yes/No	Not spec., one year
[24]	Wissem et al. (2012)	Crystalline silicon (mono & poly)	Lead-acid	PV system and storage size, PV panel slope	Cost of electricity	No/No	Not spec., one year

* FIT: Feed-in Tariff ** SC: Self-Consumption

Some authors do not specify the PV technology they model. Those that do usually opt for crystalline silicon PV (for an overview of PV technologies and their respective merits and shortcomings see [25-27]). Similarly, among the different options available for battery storage (see [28, 29] for an overview), all authors except Bost et al. [6], Braun et al. [7] and Battke et al. [13] focus on lead-acid batteries as the currently least expensive alternative for use in residential PV [30].

To economically assess the inclusion of storage in distributed PV systems, the majority of studies calculate the cost of electricity that results when installing storage of a particular size. In these studies, storage is often used as a means to reach a predefined level of energy autonomy or self-consumption (e.g. in off-grid applications), such that the chosen system configuration is generally not compared to a configuration without storage. So far, only few studies, namely Bost et al. [6], Braun et al. [7], Clastres et al. [15] and Colmenar-Santos et al. [8], explicitly compute economic revenues from storage investments. Clastres et al. [15] investigate the possibility of a household providing ancillary services and find that, even considering forecasting errors of electricity production, a household could profitably supply active power. In contrast, similar to the focus of this study, Bost et al. [6], Braun et al. [7] and Colmenar-Santos et al. [8] see the main financial incentive for investments in storage in leveraging the gap between retail and wholesale prices. They assume that, by using storage, a household may raise the self-consumption ratio, i.e. the share of PV electricity that is consumed by the household. Since this reduces both the amount of electricity to be fed into the grid at wholesale prices and the electricity to be purchased at retail prices, investing in storage may increase the household's return from the PV plant. Neither Bost et al. [6], nor Braun et al. [7], nor Colmenar-Santos et al. [8], however, find investments in storage to be profitable at the time of investigation.² Therefore, Bost et al. [6] and Braun et al. [7] additionally test profitability for future points of investment, assuming declining investment costs for both the PV system and the battery storage over time.

Both studies by Bost et al. [6] and Braun et al. [7] test for potential influences of a number of input parameters on profitability and provide interesting insights into the potential future profitability of storage. Yet, two questions remain open from these analyses. First, in both studies it is assumed that the household receives a premium paid on top of electricity market prices for PV-generated electricity that is self-consumed or fed it into the grid. This assumption reflects the current regulatory situation in the German energy market under the Renewable Energy Sources Act, which Bost et al. [6] and Braun et al. [7] investigate. However, both the feed-in premiums and self-consumption incentives paid have been subject to considerable change in the recent years [9]. The feed-in tariff for PV has fallen by more than 43 percent from 2009 to 2011 and has already reached a level that is below average retail prices. PV will have to compete in a market with other sources of electricity without policy support in

² Note that Bost et al. (2011), following the logic of the 'grid parity' concept, evaluate the profitability by comparing levelized cost of electricity with a mix of retail and wholesale price that depends on the self-consumption ratio of the household. Braun et al. (2012) and Colmenar-Santos et al. (2012), in contrast, use the metric of internal rate of return.

the foreseeable future. Under a regime with no demand-side policy support storage profitability will strongly depend on market electricity prices. In their studies Bost et al. [6] and Braun et al. [7] consider different electricity retail price developments. However, as they assume the existence of FITs, they do not investigate the effect of different wholesale price scenarios and the possibility of the household having limited access to the wholesale market.

Second, whereas the majority of studies listed in Table 1 explicitly optimize the size of both the PV system and the storage for a given electricity consumption to achieve a minimum cost of electricity, this is not the case for Bost et al. [6] and Braun et al. [7].³ Systematically testing for a wider range of different PV-storage-combinations is important since the self-consumption ratio, and hence the financial return of the storage investment, is highly sensitive to the assumed PV and storage size. Choosing the PV system sufficiently small can lead to very high self-consumption ratios even without storage since beyond a certain point almost all supply is backed by household demand. Accordingly, Bost et al. [6] themselves point out that, while the size of PV plants in Germany has risen over the last years, increasing incentives to self-consume PV electricity (due to falling FITs and additional self-consumption incentives) may lead to a trend toward smaller PV plants. Currently, however, it remains unclear to which extent economic optimization of PV system and storage size affects the profitability of storage over time. In particular, it appears interesting to investigate whether and when economic optimization of PV system and storage size allows operating storage profitably in an environment without policy support.

3 Data and Method

In the subsequent sections, we explain the design and input parameters of our techno-economic model. Following the general logic depicted in Figure 1, we first describe the system layout and boundaries (section 3.1). Next, in section 3.2 the technological and economic input parameters of the model are presented, including the eight electricity price scenarios we employ. We provide a detailed explanation of the different modules of the model and discuss how they interact to produce the simulation results in section 3.3. The model output and the sensitivity analysis we conducted are described in section 3.4.

3.1 System Boundaries and Layout

To investigate the economic viability of storage in distributed PV systems, we simulate electricity generation and consumption for a three-person household in Stuttgart, Germany. Similar to the studies

³ In their model, Braun et al. [7] only vary the storage size and keep the PV system size constant. Bost et al. [6] simulate different sizes of both the PV system and storage but do not systematically optimize these two parameters with regard to an economic objective function.

by Bost et al. [6] and Braun et al. [7], Germany was chosen as a country as it has the largest share of PV in its electricity mix, operating more than 35 percent of the worldwide installed PV capacity in 2011. The resulting intermittency in electricity generation makes Germany a potentially important market for storage solution providers [31]. Although, due to falling prices for PV systems, the average size of PV plants in Germany has constantly risen over the years, a large share of the German PV market is still made up of small-scale, residential PV systems. For example, of the more than 73,000 PV plants installed in Germany from January to April 2012, more than 47% had a size of less than 10 kW_p and more than 85% a capacity of less than 30 kW_p [32]. A three-person household was chosen to make the results of this study comparable to previous studies of PV systems in Germany, which have usually investigated households of similar sizes.

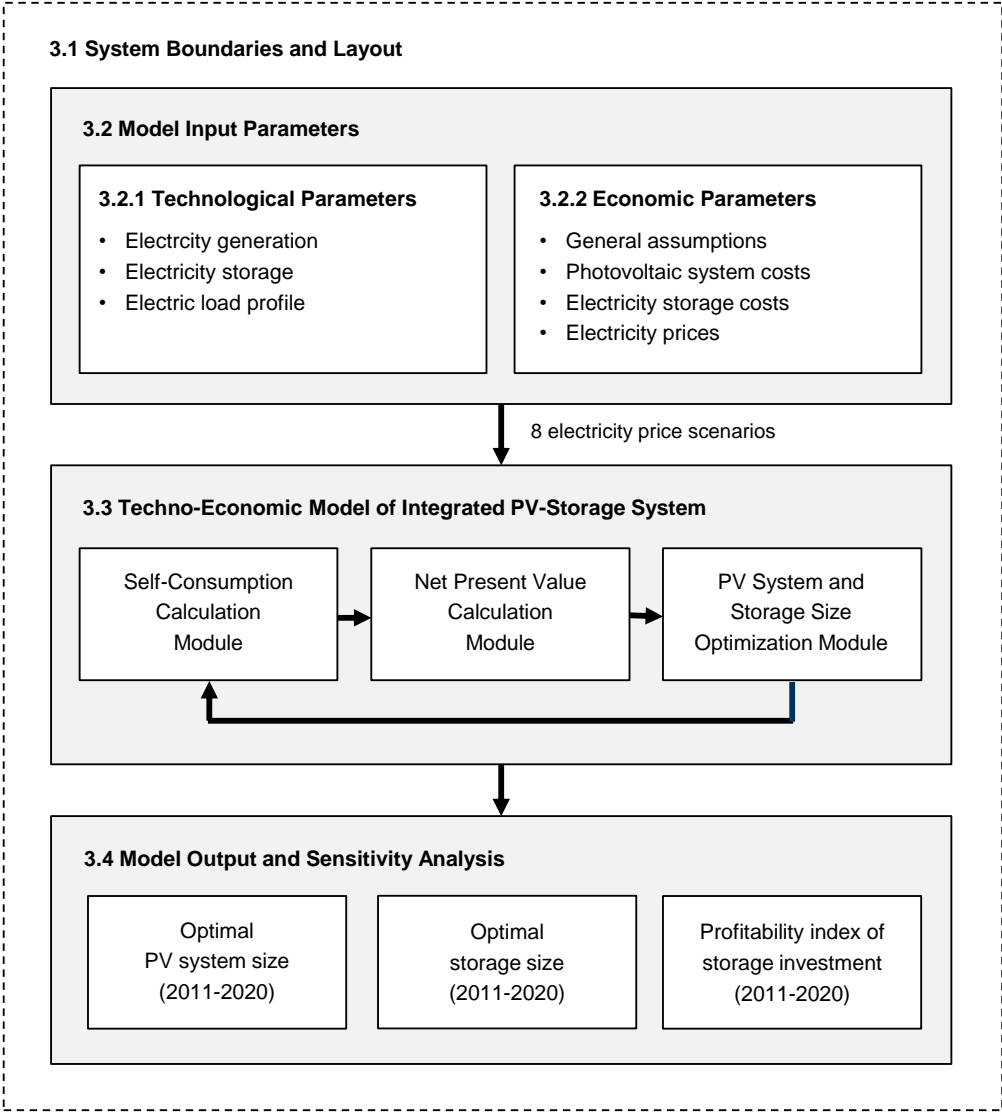

Figure 1: Overview of model structure

The layout of the integrated PV-storage system to be investigated is shown in Figure 2. It consists of the PV system, battery storage, two DC-AC inverters and an AC bus.⁴ This system layout is the most widely used one in the literature, considered economically efficient and suitable for domestic applications and producing minimal losses [30, 33, 34]. The detailed mode of operation of the system as assumed in our model will be described in section 3.3.

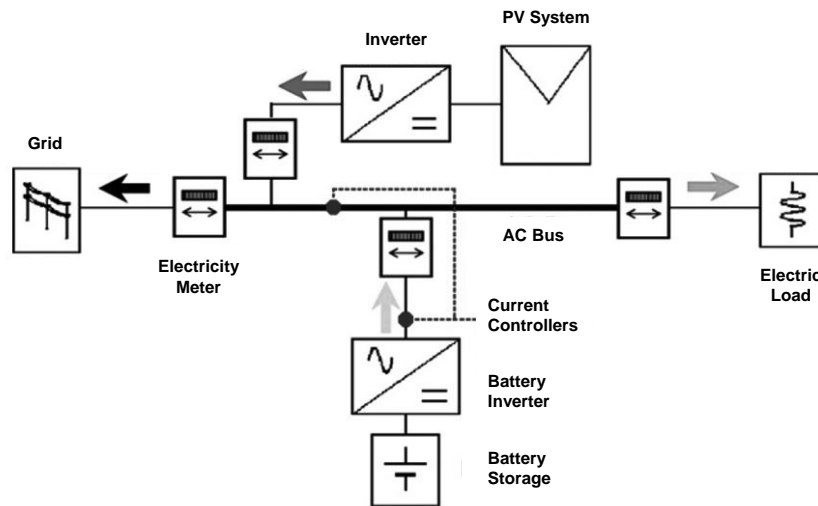

Figure 2: Layout of integrated PV-storage system [34]

3.2 Model Input Parameters

3.2.1 Technological Input Parameters

The technological input parameters can be broadly divided into three categories: those pertaining to electricity generation, the electricity storage and the electric load. In the following, each of the categories will be discussed separately.

Electricity Generation

The PV electricity production in kWh per kW_p is a function of the available global horizontal solar irradiation, the outside air temperature as well as the tilt, orientation and performance characteristics of the PV module. Hourly solar irradiation data for Stuttgart, Germany, was obtained from the EnergyPlus weather database provided by the U.S. Department of Energy [35]. Orientation and tilt

⁴The electricity generated by the PV system is inverted and transmitted to an AC bus where it can either be directly assigned to the loads of the household (right), stored in the storage (bottom) or transmitted to the grid (left). To store electricity, the electricity fed into the storage is tapped from the AC bus, inverted to DC and stored. When the household needs to access electricity from the storage, the DC power in the battery is re-inverted to AC and fed into the household through the AC bus.

were chosen such that the PV modules could operate under optimal conditions. In southern Germany, this corresponds to a southward orientation and a tilt of 30° [26].

In line with previous studies (see section 2) we choose crystalline silicon as a PV technology. This choice is made as currently crystalline silicon PV offers higher conversion efficiencies than thin-film PV and therefore has a market share in residential markets that exceeds 86% [36]. To reflect inefficiencies in the PV system, such as inversion losses, the PV system rated output is multiplied with a performance ratio (PR) of 85%.⁵ In sum, the chosen parameters lead to an annual electricity generation of 980.93 kWh/kW_p.

Electricity Storage

Similar to the majority of previous studies (see section 2), we choose lead-acid batteries as the storage technology for our model. Compared to other battery technologies, lead-acid batteries have a short lifetime and low energy and power density. However, currently, due to their high reliability, low self-discharge as well as low investment and maintenance costs, they are the dominant technology in small scale, residential applications [30, 33, 39]. Several authors argue that in the longer-term lead-acid could be replaced by lithium-ion batteries that possess better ageing features and a higher energy efficiency [7, 29, 40]. At present, however, lithium-ion batteries are still in a relatively early phase of development and 3.5 times as expensive as lead-acid [30]. Furthermore, in the case of stationary use, the lower energy and power density of lead-acid batteries are not as critical as, for example, in electric mobility. Based on a comprehensive literature review (see Table A.1 in appendix), the round-cycle efficiency of the battery system was set to 81% and the self-discharge per day to 0.03%.

Electric Load Profile

We use standard load profiles for household electricity consumption in Germany at a resolution of 15 minutes [41]. The load profile was scaled to an annual consumption of 3.908 kWh to reflect the pattern of a three-person household in Germany [6]. Moreover, to be consistent with the electricity consumption profile, the data was transformed from a resolution of 15 minutes to one hour by adding up the values within every hour. Figure 3 juxtaposes the resulting electricity load with electricity generation for the case that annual electricity generation of the PV system equals the annual consumption of the household. It becomes apparent that without storage there is a strong mismatch between the electricity produced and generated which varies over the year.

⁵ We deliberately choose a slightly higher value than the average PR of 84% found by Reich et al. [37] as we separately account for losses due to temperature and degradation. In line with Jordan et al. [38] module efficiency decreases at a rate of 0.5% per year. The temperature coefficient was chosen to be 97.8% [26].

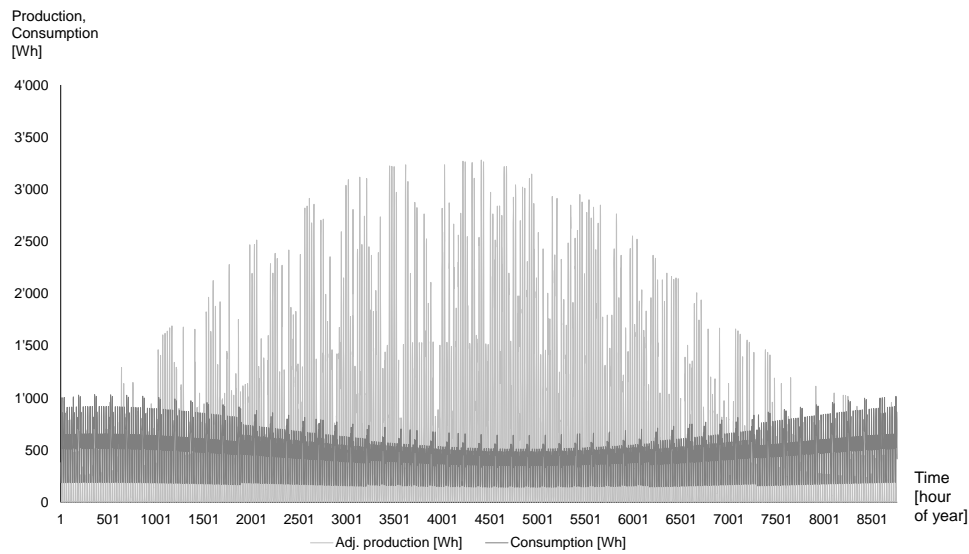

Figure 3: PV electricity generation vs. electric load over year for annual consumption equaling annual production without storage

3.2.2 Economic Input Parameters

In the following we present the economic input parameters of the model. We first review some general assumptions and discuss the assumptions regarding the costs of the PV system, the battery system and electricity prices. It is important to note that, while we conducted a comprehensive review of previous studies and market data to identify the input values for our model, often the range of possible values remains relatively broad. For this reason we use 8 scenarios for electricity prices. In addition, we performed a sensitivity analysis to test the robustness of the model against changes in the other input parameters (see section 3.3).

General Assumptions

Since we are modeling a household in southern Germany, we choose Euro as the currency and assume inflation to be the one of the Euro zone, i.e. 2.1% [42]. Based on a review of previous studies, 4% is chosen as a value for the nominal discount rate.

Photovoltaic System Cost

Table 2 lists the model input parameters related to the PV system costs that were retrieved from the literature, annual reports of technology producers, industry reports and expert interviews. The overall PV system costs consist of the costs for the PV modules, the inverter, balance of system and engineering, procurement and construction. To be able to assess the economic viability of storage for distributed PV in the future, we applied a learning curve approach that allows estimating future investment costs based on the cumulative global deployment of PV. The learning rates used for the PV module, inverter and balance of system (BOS) are listed in Table 2, data for future PV deployment is obtained from EPIA [43] (see Figure A.1 in the appendix).⁶ Learning rates were applied to the cost, not the price, of the PV system components, assuming a long-term EBIT margin of 10%. Figure 4 exemplarily shows the resulting PV investment cost for 2013, 2017 and 2021.

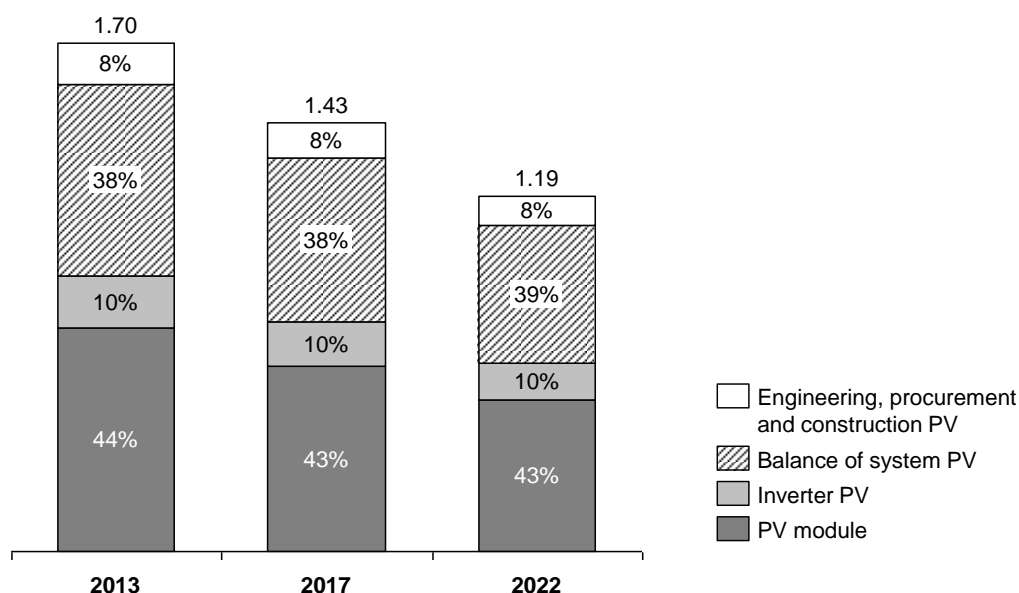

Figure 4: Assumed PV investment costs (nominal) in EUR/W_p

⁶ We take the average of EPIA's [43] 'moderate' and 'policy-driven' scenarios in which PV deployment grows at an annual rate of 18% and 25% respectively. Considering that PV deployment since 1994 has grown at an average rate of 35%, our assumed market growth of 22% is rather conservative.

Table 2: Economic input parameters for PV system

Category	Parameter	Value	Source
PV module	Average module price 2013 (incl. profit)	0.75 EUR/W _p	pvXchange [44]
	Learning rate PV module	20%	Kost and Schlegl [45] Wand and Leuthold [46] Junginger et al. [47]
	Module lifetime	25 years	See Table A.3 in appendix
Inverter	Average inverter price 2013 (incl. profit)	0.17 EUR/W _p	Annual reports of SMA AG
	Learning rate inverter	18%	Annual reports of SMA AG, own calculation
	Inverter lifetime	15 years	EPIA [48]
Balance of systems	Sales price BOS PV system 2013	0.64 EUR/W _p	BSW Solar [49]
	Learning rate BOS PV system	18%	Schaeffer [50]
EPC* & operations and maintenance	EPC* PV system	8% of PV system cost (incl. inverter)	Peters et al. [26]
	Operations and maintenance cost PV	1.5% of PV system cost (incl. inverter) per year	Peters et al. [26]

* EPC: Engineering, procurement and construction

Electricity Storage Cost

The economic parameters for lead-acid storage used in our model are summarized in Table 3. The battery investment cost is calculated by adding up the energy and power cost of 171 EUR/kWh and 172 EUR/kW respectively [13]. This procedure was recommended by experts we consulted on this issue. While studies differ considerably with regard to their assessment of future cost decreases, it has been pointed out that, in general, lead-acid batteries still offer significant potential for cost improvements. Therefore, in line with VDE (2009), a constant decrease in battery investment costs of 7.6% per year is assumed. Furthermore, similar to the PV system, inverter costs are modeled as a function of the maximum power input to or output of the storage. The resulting investment costs for the storage system are displayed in Figure 5. Since the battery is assumed to have a life time of 8.3 years, it is replaced twice during the life of the PV system.

Table 3: Economic input parameters for battery storage system

Category	Parameter	Value	Source
Battery	Battery investment costs in 2013	171 EUR/kWh + 172 EUR/kW	Battke et al. [13]
	Battery investment cost decrease	-7.6% per year	VDE [40]
	Battery life time	8.3 years	Battke et al. [13]
Inverter	See Table 2		
Balance of systems	BOS storage	70 EUR/kW	Battke et al. [13]
EPC and operations and maintenance	EPC battery system	8% of battery system cost (incl. inverter)	See Table 2
	Operations and maintenance cost battery	22 EUR/kW per year	Battke et al. [13]

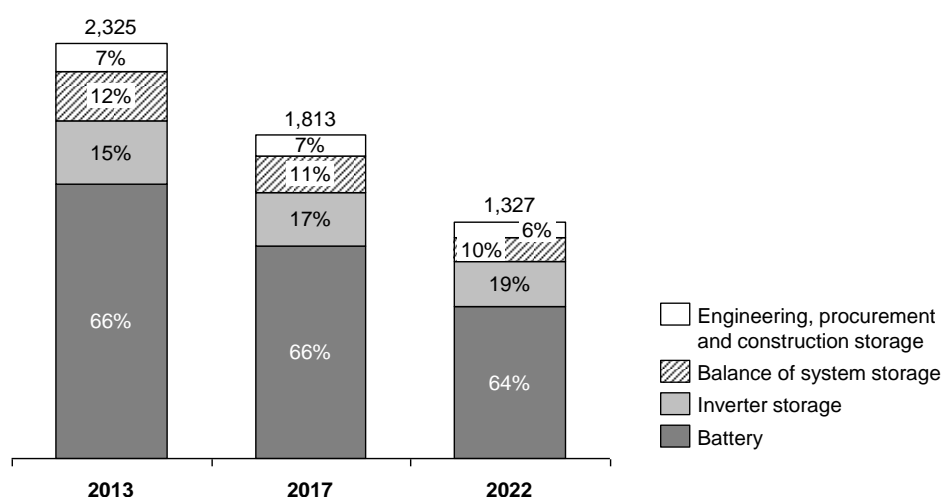

Figure 5: Assumed investment costs (nominal) in EUR for 5 kWh storage for annual PV electricity generation equaling annual household consumption

Electricity Prices

As discussed in section 2, the economic viability of storage in a regime without policy support is likely to be strongly affected by the present and future level of retail and wholesale electricity prices. According to BDEW [51], the average retail price in Germany in 2013 amounted to 0.2884 EUR/kWh.⁷ As a wholesale price we chose 0.042 EUR/kWh. The latter value was also obtained from

⁷ In accordance with the majority of private electricity contracts in Germany, we assume that the retail price is the same for the entire day, i.e. there is no special night tariff.

BDEW [51] and constitutes the average wholesale price during peak hours, i.e. weekdays from 8 a.m. to 8 p.m. Since the time of PV net electricity production falls into this time range, the price was considered a valid starting point for our analysis.

The future development of both wholesale and retail electricity prices is highly uncertain. To evaluate a range of possible developments in our model, we applied eight electricity price scenarios (see Table 4).

Table 4: Electricity price scenarios used in model simulations

Scenario	Assumption	Electricity Wholesale Price Scenario	Electricity Retail Price Scenario
S1	Unlimited access of household to wholesale market	High: +3% per year (real)	High: + 2% per year (real)
S2		Low: -1% per year (real)	
S3		Medium: + 1.5% per year (real)	Medium: + 1% per year (real)
S4		High: +3% per year (real)	Low: + 0% per year (real)
S5		Low: -1% per year (real)	
S6	No access of household to wholesale market	Constant: 0 EUR/kWh	High: + 2% per year (real)
S7			Medium: + 1% per year (real)
S8			Low: + 0% per year (real)

The first five scenarios (S1 to S5) assume that the household has unlimited access to the wholesale market and contain three possible developments for each wholesale and retail prices. In scenarios S2 and S5 wholesale prices are assumed to fall, which would reflect the current observation that an increasing supply of renewable electricity sources with low variable costs tends to lower wholesale prices (so-called ‘merit order effect’). However, due to the intermittent nature of the former technologies a change in the structure of the entire electricity market might become necessary to incentivize the provision of additional, flexible capacity with higher variable cost (e.g. through so-called ‘capacity markets’). As the latter might lead to rising, rather than falling wholesale prices, we include scenarios in which wholesale prices rise by 1.5% (S3) and 3% annually in real terms (S1 and S4). Apart from electricity generation cost, retail prices in Germany include grid fees, the utility’s profit margin, taxes and the ‘EEG apportionment’, the latter containing the cost of the feed-in tariff that is redistributed to the consumer. The increasing deployment of renewables in Germany is likely to raise retail prices in the foreseeable future through the EEG apportionment and additional investments in the electricity grid. Since the exact amount of increases in retail prices is uncertain, based on a literature review (see Table A.4), we investigate three possible developments, namely real increases of 2% (scenarios S1 and S2), 1% (scenario S3) and 0% (scenarios S4 and S5).

Currently, it remains uncertain to what extent households will be able to directly sell their electricity on the wholesale electricity market.⁸ Moreover, wholesale prices fluctuate considerably during the day with dips occurring when many renewable plants simultaneously feed in their electricity, e.g. during noon. To consider these possibilities, we test three extreme scenarios at which wholesale prices are assumed to be 0 EUR/kWh (S6 to S8). Since we model investment decisions from 2013 to 2022 for a PV system with a lifetime of 25 years, electricity prices are extrapolated until 2047 in all eight scenarios. Compared to previous studies, our maximum price increases are chosen rather conservatively. Nevertheless, it should be noted that under our assumptions in the high price scenarios, retail and wholesale price in 2047 reach a level of 0.57 EUR/kWh and 0.11 EUR/kWh in 2013 prices respectively (see Figure A.2 in the appendix).

3.3 Techno-Economic Model of Integrated PV-Storage-System

The following sections describe how the values are processed in the model to generate our results. We first present the three main modules of the model – 1) the self-consumption calculation module, 2) the net present value calculation module and 3) the storage and PV size optimization module.

Self-Consumption Calculation Module

As the basis for the economic calculations, in a first step the self-consumption ratio (SCR), i.e. the share of electricity generated by the PV system that is consumed by the household, is calculated. Figure 6 portrays the general logic underlying the calculation. It is assumed that whenever electricity demand during the day can be met by the concurrent electricity generation of the PV system, the household consumes its own electricity (see number 4 in Figure). If electricity generation exceeds household consumption, electricity is either stored for later consumption (2) or sold to the grid if the storage is loaded (3). The ratio between electricity that is directly self-consumed (4) or taken from storage later (5) and the total electricity generated by the PV system (2+3+4) defines the self-consumption ratio. For a given electricity consumption, this ratio is directly dependent on the size of the PV system and the size of the battery storage. In the model, the self-consumption ratio is calculated by simulating the electricity flows of the system over the year at an hourly resolution. The self-consumption ratio serves as an input to the second module of the model which calculates the net present value of the integrated PV-battery system for the household.

⁸ In the short term, the assumption that households can sell their electricity on the wholesale market requires a preferential feed-in of PV as established under the German Renewable Sources Act since the handling of a large number of intermittent electricity sources on the market is difficult. In the longer-term, when electricity costs of solar PV have fallen further and intermediary institutions have been established that bundle and market solar PV power, it seems possible that solar PV can be marketed on the wholesale market without preferential treatment.

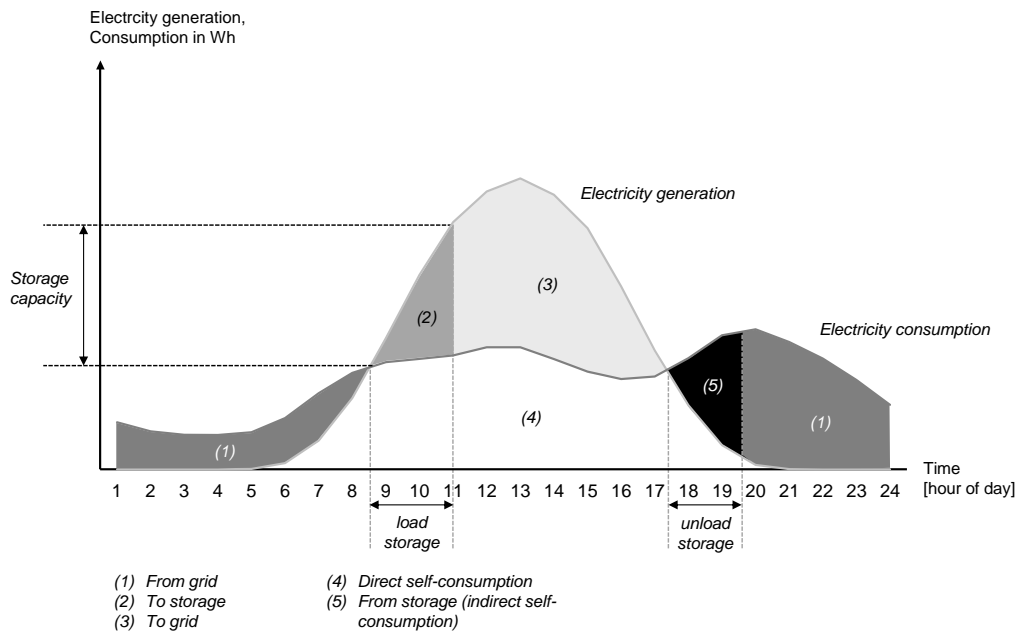

Figure 6: General logic of self-consumption calculation module (illustrative)

Net Present Value Calculation Module

For a given investment year t , the net present value (NPV) of household investments is calculated as the sum of the discounted cash in- and outflows over the 25 year lifetime of the PV/battery system.⁹ As shown in detail in appendix B, cash outflows comprise the investment costs for the PV system and battery system as well as the operations and maintenance expenses (see section 3.2). For the cash inflow it is assumed that with consuming electricity from the own PV system, the household substitutes electricity that it would otherwise have to purchase from the electric utility at retail prices. Excess electricity that is neither self-consumed nor stored is sold at wholesale prices. The revenues of the household are then calculated as the sum of 1) the self-consumed electricity (i.e., the product of electricity generated during each year of system lifetime multiplied and the SCR) multiplied with the retail electricity price and 2) the electricity sold (i.e., the product of the electricity generated during each year of system lifetime and $1-SCR$) multiplied with the wholesale electricity price.

⁹ Since in Germany, households have access to low-interest loans from ‘KfW bank’, in general the availability of capital does not constrain the size of PV systems and storage to be invested in. As a result, the households can be considered to maximize the absolute return from the integrated PV-storage system, irrespective of its size. In our model, we therefore use (and maximize) the NPV as a measure of profitability.

Storage and PV System Size Optimization Module

The third module draws on the inputs from the “Self-Consumption Calculation Module” and the “Net Present Value Calculation Module” to find the optimal storage and PV system size for the household. For each investment year from 2013 to 2022 and each of the eight electricity price scenarios (see Table 4 in section 3.2) the module calculates the net present value for 1,435 different combinations of PV system and storage sizes (35 PV system sizes times 41 storage sizes). Based on these values, the PV system and storage size are identified that maximize the NPV of the overall PV-storage system (see appendix C for a more detailed description of the calculation procedure). Tested PV system sizes range from 0.4 kW_p to 14 kW_p and are incremented at steps of 0.4 kW_p. 14 kW_p was chosen as the maximum since the PV capacity that can be installed on village houses in Germany was, on average, found to be limited to this value [52]. The storage sizes tested by the model range from 0 kWh (i.e. no storage) to 20 kWh and are increased at intervals of 0.5 kWh. Note that the model assumes a depth of discharge of the battery of 80%, i.e. the usable battery capacity is lower than the nominal values indicated.

3.4 Model Output and Sensitivity Analysis

Overall, for each investment year from 2013 to 2022 and each of the eight electricity price scenarios the model generates three main outputs:

- 1) The economically optimal size of the PV system,
- 2) the economically optimal size of the storage system and
- 3) the profitability of the storage investment.

As described in the previous section, the optimal PV system and storage size are those that maximize the NPV of the integrated PV-storage system. As a measure for profitability of the storage investment, we use the profitability index (PI) which is defined as the quotient of the NPV of the storage investment and the storage investment cost at the time of investment.¹⁰

To investigate the robustness of the model with regard to variations in the input parameters, a sensitivity analysis was conducted. As part of this analysis the 13 most important input parameters that had not been modeled as scenarios were augmented and lowered by 33% of their original value one at a time for scenario S3 (which assumes medium increases of both retail and wholesale price). The results of this analysis will be presented in section 4.4 after describing the general simulation results.

¹⁰ We use the profitability index to measure storage profitability instead of the NPV since we optimize the storage size for different points in time of investment. The differences in optimal storage size over time would make the profitability of storage hard to compare if we used an absolute measure of profitability. Therefore, we report the storage profitability as the NPV per EUR invested. The optimal storage size over time is reported as a separate output variable.

4 Results

In the following, we describe the model outcomes, i.e. the optimal PV system size (4.1), the optimal size of storage (4.2) and the profitability of storage for a rationally optimizing household for the years of investment from 2013 to 2022 and the eight electricity price scenarios (4.3). Finally we present a sensitivity analysis of the key input parameters (4.4).

4.1 Optimal PV System Size

The development of the optimal PV system size as well as the corresponding electricity production/consumption ratio for an economically rational household under the 8 electricity price scenarios is shown in Figures 7 and 8. The production/consumption ratio describes the quotient of the annual electricity generated by the PV system and the annual electricity consumption of the household.

As can be seen, under a medium electricity retail price, medium electricity wholesale price scenario (S3) the optimal size of the PV system the household invests in rises strongly over time. Most importantly, investments in the PV system are profitable for the household throughout the period of investigation, which is indicated by the fact that the size of the PV system is always different from zero.¹¹ In early years, however, the optimal PV system size is chosen such that the PV system generates less electricity than the household consumes (i.e. the production/consumption ratio is smaller than 1). This is due to the fact that investment costs for both the PV and the storage system are relatively high, requiring the household to have a high rate of direct self-consumption which can only be reached when choosing a small PV system size. With falling investment costs, however, the optimal production to consumption ratio increases to reach a point where after 2017 annual PV electricity generation exceeds the electric load of the household. Subsequently, the optimal PV system rises further until in 2022 under the S3 scenario its size reaches the maximum PV system size of 7 kW_p.

¹¹ It should be emphasized that our finding that already in 2011 PV systems in Germany were profitable without policy support hinges on a number of assumptions: a) The household needs to optimize the size of the PV system since only small systems are profitable in early years, b) electricity prices need to develop as indicated in our scenarios and c) costs for engineering, procurement and construction depend mostly on the size of the system (i.e. they do not contain a large fixed component which may be the case for very small PV systems).

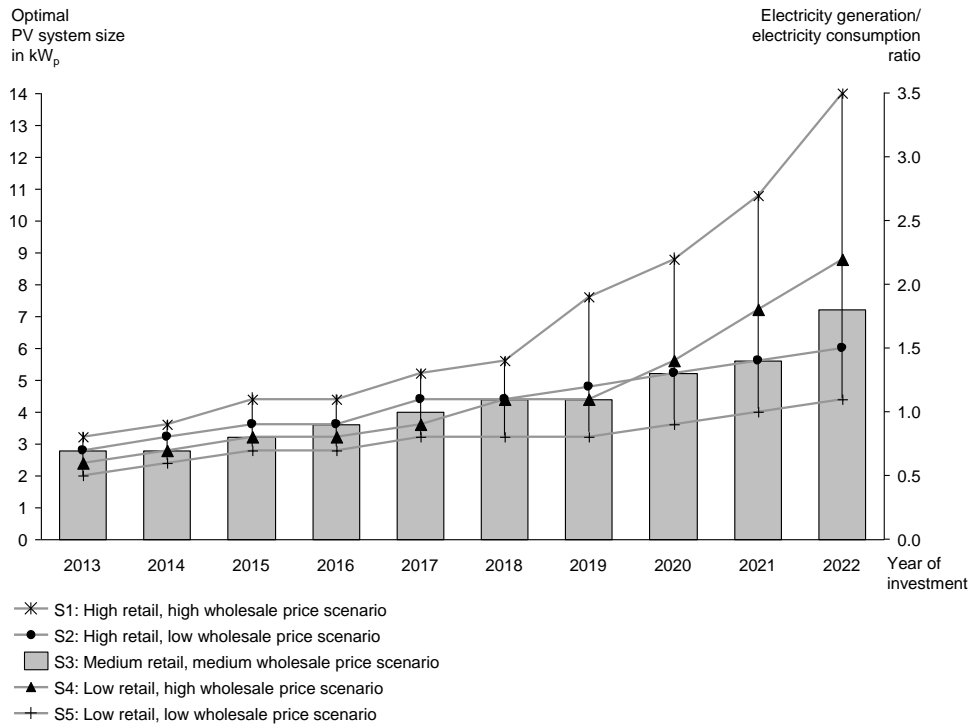

Figure 7: Optimal PV plant size under electricity price scenarios S1 to S5

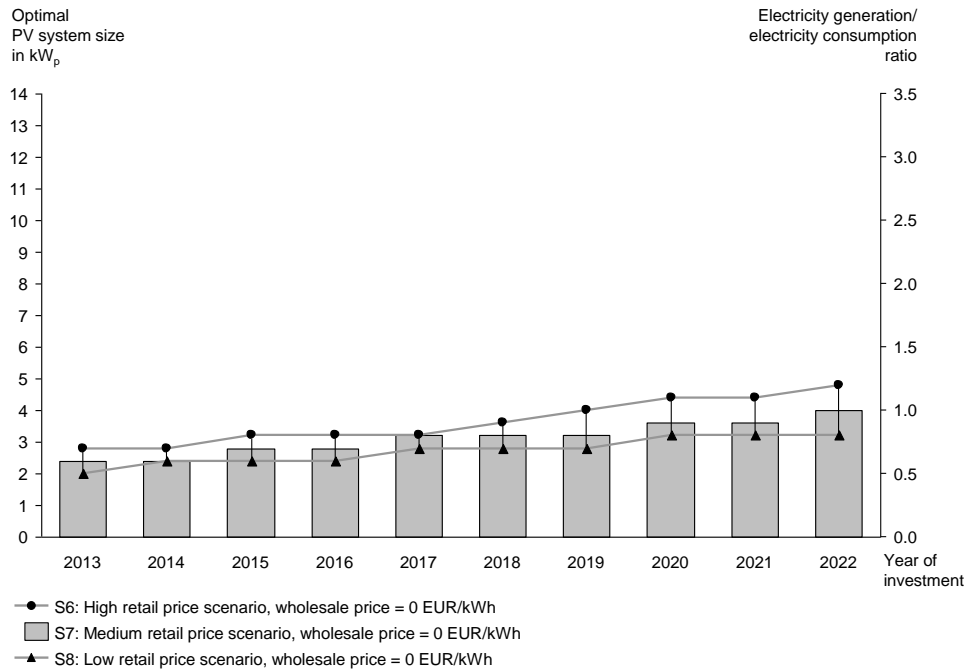

Figure 8: Optimal PV plant size under the assumption that the household cannot sell electricity on the wholesale market (electricity price scenarios S6 to S8)

As shown in scenarios S1, S2, S4 and S5 in Figure 7, the optimal PV plant size is very sensitive to both future retail and wholesale electricity prices. Stronger increases in retail prices (scenarios S1 and S2) favor larger PV plant sizes since they enhance the value of the electricity produced by the PV system – which substitutes electricity purchased from the grid. Similarly, for a given retail price scenario, the optimal PV system size is higher for higher wholesale prices (S1 and S4) since excess electricity can be sold on the market at higher prices. Interestingly, while retail prices are the factor that influences PV system size most strongly in early years, wholesale prices become more important during the later periods. This can be explained by the fact that with falling technology costs, the size of PV plants rises over time which leads to a situation where households, despite using storage, need to sell an increasing share of their electricity on the wholesale market. Under the assumption that the household does not have access to the wholesale market, the optimal PV system size is considerably smaller than the one for scenarios where the household can not only consume but also sell its electricity (see S6 to S8 in Figure 8). As could be expected, the household chooses the PV system size such that the electricity it produces almost never exceeds the electricity the household consumes.

4.2 Optimal Storage Size

Figures 9 and 10 display the development of the optimal storage size. Under the medium electricity retail price, medium electricity wholesale price scenario (S3), the optimal storage size amounts to 4.5 kWh storage in 2013 and rises significantly to reach 7.0 kWh in 2020. The fact that the optimal storage size levels out is due to the fact that our model includes a constraint for the maximum PV system size which dampens the size of storage that is installed under economic considerations.

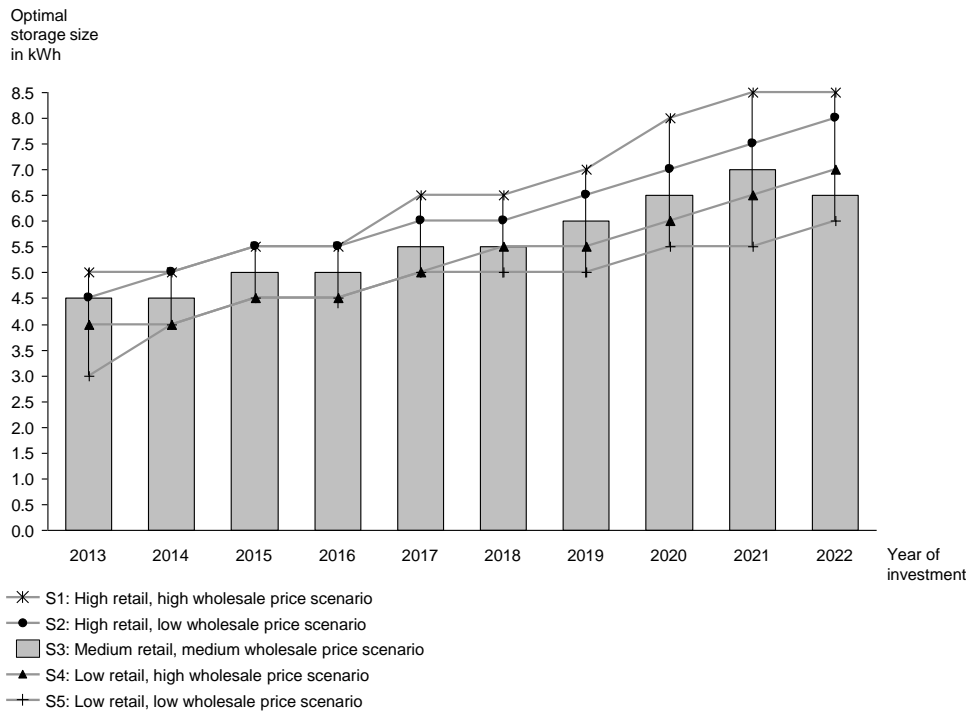

Figure 9: Optimal storage size under electricity price scenarios S1 to S5

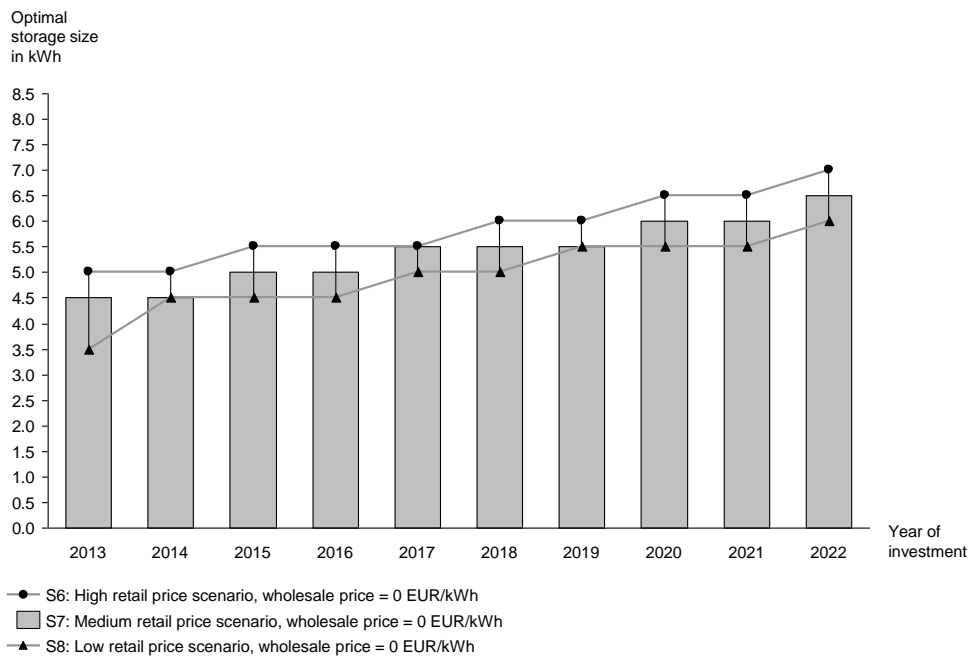

Figure 10: Optimal storage size under the assumption that the household cannot sell electricity on the wholesale market (electricity price scenarios S6 to S8)

Similar to the optimal PV system size, the optimal storage size in early years depends particularly on the assumed retail price developments. Under the assumption of strong increases in future retail prices, the household invests in 4.5 to 5 kWh storage as early as 2013 (scenarios S1 and S2), whereas when assuming a stagnation in retail prices (real) only 3 to 5 kWh storage are added (scenarios S4 and S5). Interestingly, given a particular retail price increase, the optimal storage size is slightly larger for scenarios that assume a stronger increase in wholesale prices (see scenarios S1 vs. S2 and scenarios S4 vs. S5). At a first glance, this result seems counterintuitive since one might assume that storage becomes particularly important when wholesale prices are low such that a household does not have to sell electricity on the market at low prices. Yet, this finding can be explained by the fact that higher wholesale prices trigger investments in larger PV plants (see previous section), which in turn raises the optimal storage capacity. Overall, however, the impact of wholesale prices on the optimal storage size is relatively small. Even when assuming a constant wholesale price of 0 EUR (i.e. no possibility for households to sell their electricity on the wholesale market) the optimal storage is almost identical to a scenario where the household can sell the electricity at a medium wholesale price (see scenarios S6 to S8 in Figure 10).

4.3 Storage Profitability

The development of storage profitability over time (excluding the PV system) is shown in Figures 11 and 12. Investments in storage are already profitable in 2013 under all electricity price scenarios. Furthermore, due to falling investment costs, the profitability of storage continuously rises over time in an almost linear fashion. Under the assumptions of our model, in the S3 scenario, the storage PI rises from 0.4 in 2013 to 2.66 in 2022.

Like the optimal storage size, storage profitability depends mostly on retail prices. Assuming a higher retail price scenario raises the profitability for all years under investigation (see scenarios S1 and S2), whereas a low retail price scenario lowers it (scenarios S4 and S5). Under the assumption of a stronger increase in future retail electricity prices, storage is profitable as early as 2013. Lower wholesale electricity prices raise the profits to be gained from storage investments in later years when PV systems are large and households tend to sell a higher share of their electricity on the market (see scenarios S2 and S5). Correspondingly, investments in storage remain profitable even under the assumption of a constant wholesale price of 0 EUR, i.e. no access of households to wholesale markets (see scenarios S6 to S8 in Figure 12).

Net present value of storage
per EUR invested in storage

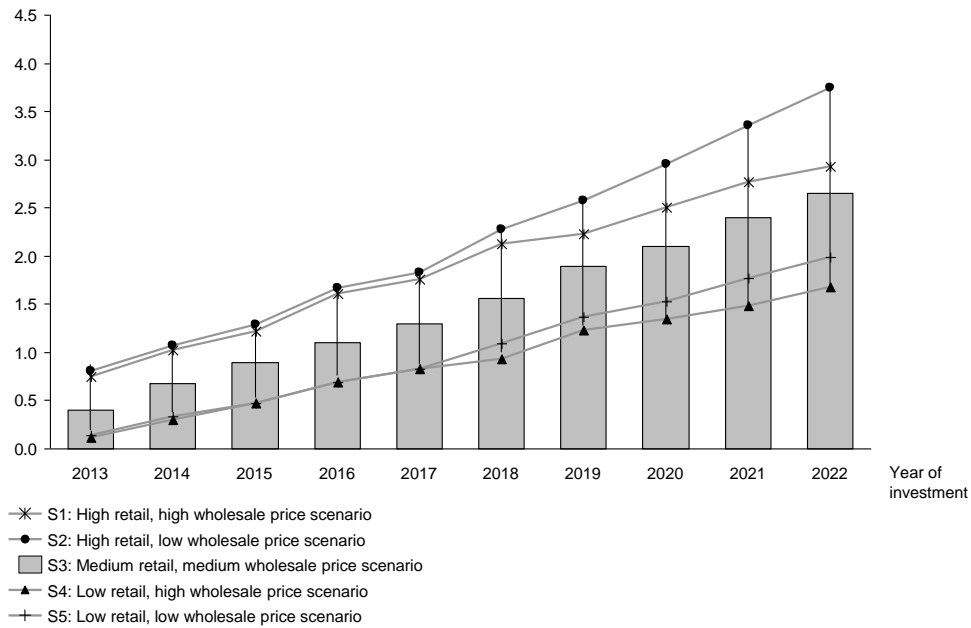

Figure 11: Storage profitability under electricity price scenarios S1 to S5

Net present value of storage
per EUR invested in storage

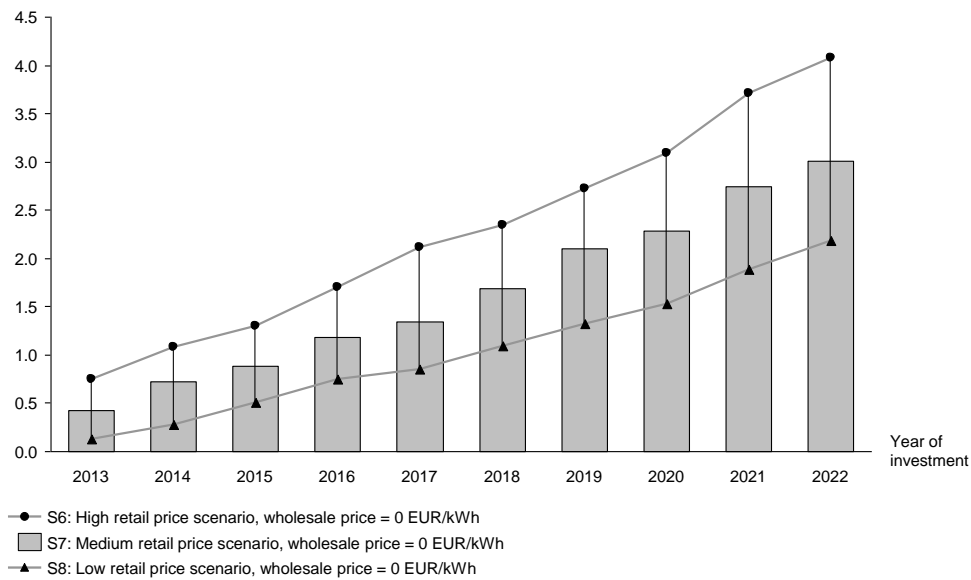

Figure 12: Storage profitability under the assumption that the household cannot sell electricity on the wholesale market (electricity price scenarios S6 to S8)

4.4 Sensitivity Analysis

Figure 13 shows a tornado graph on how the profitability index (i.e. the NPV of the storage investment per EUR invested in storage) changes when varying the most important input parameters, that are not covered by the scenarios, by -33% and +33%. It becomes obvious that of all input parameters, the nominal discount rate and the battery investment cost reduction have the greatest effect on the model outcome. Moreover, the model is sensitive to changes in the assumption of future battery cost decreases and the assumed increase in the global installed PV capacity (the latter determining the technological learning and hence the investment costs of PV).

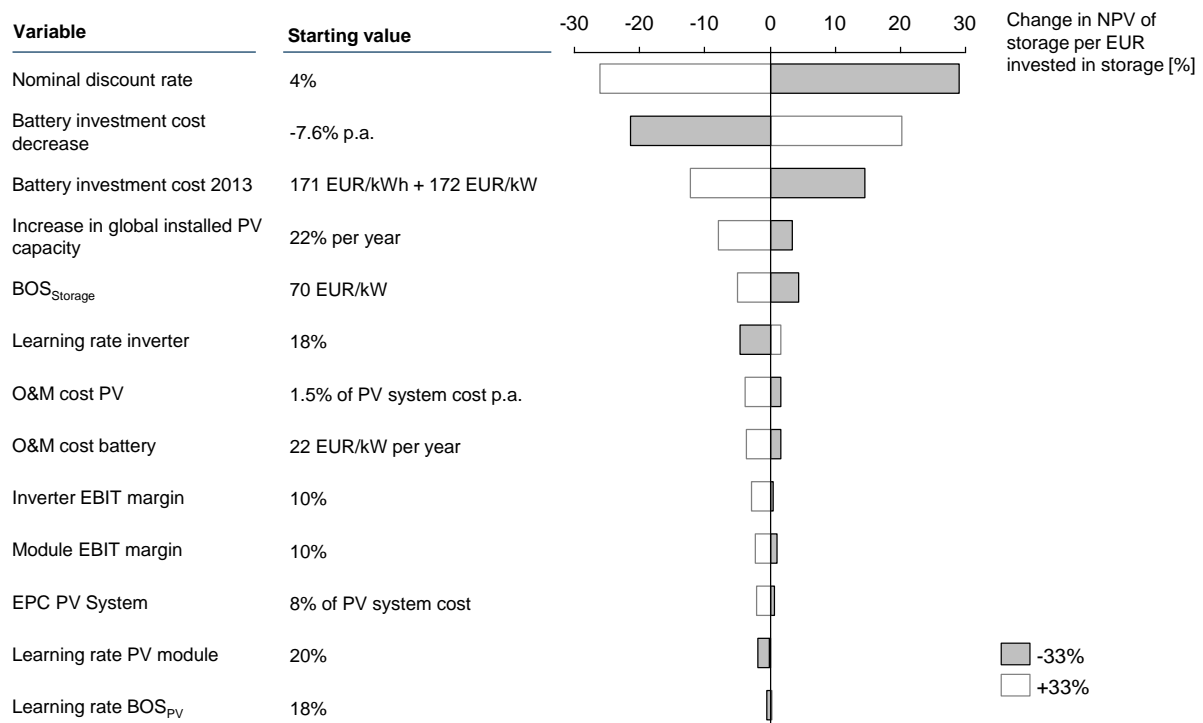

Figure 13: Sensitivity analysis of the most important input parameters under scenario S3

5 Discussion

In the following we discuss the implications of our findings for private households, the broader electricity sector and policy makers.

5.1 Implications for Household Investments

The findings presented in the previous section demonstrate that already now battery storage is economically viable for small PV systems under all electricity price scenarios. Especially those scenarios that, in line with current trends in Germany, assume a decrease in electricity wholesale prices and a concurrent increase in electricity retail prices lead to a high economic viability of storage investments. Moreover, if households are assumed to have limited access to the wholesale market in the future, this does not undermine but may even bolster storage profitability.

The early profitability of storage for residential PV without policy support is striking and can be assumed to have a major impact on household investments. Nevertheless, we caution to conclude that a high profitability of integrated PV-storage systems will automatically imply a strong adoption of these technologies by households starting at this point in time. Despite being profitable, PV systems (with and without storage) may not be installed for several reasons. First, in stark contrast to investments under a feed-in tariff scheme, returns from investing in PV are much less certain under a regime without policy support. Given that market prices fluctuate significantly and the future development of both wholesale and retail prices remains unclear, future cash flows are difficult to predict. This is especially true if one considers that policy makers may take measures in the future that change the profitability of PV and storage investments. At the moment, for example, households in Germany that consume self-generated electricity do not have to pay electricity taxes, the EEG apportionment and grid fees. Since this puts an increasing burden on electricity consumers that do not own a PV system, it seems likely that policy makers will take measures to have owners of PV systems carry some of these costs in the future. Moreover, the individual load patterns of households deviate from the standard load pattern used in our analysis. In our analysis the household optimizes the size of both the PV and storage system to maximize its revenues. In reality, such optimization will be very hard to do as load patterns may be unknown or change over time and PV/storage systems will be offered in standardized sizes. The uncertainties regarding future electricity prices and difficulties in assessing the benefits from storage may prevent households from investing in PV and storage technologies. Second, apart from economic considerations, the adoption of PV and storage technologies by households strongly depends on social and environmental factors. Household investments are strongly driven by the knowledge about investment opportunities and the ability to overcome behavioral barriers.

5.2 Implications for Environmental Pollution, Safety and Maintenance

Solar photovoltaic plants generate considerably less emissions over the life-cycle than plants fueled by coal or gas [53]. However, the increasing profitability of battery systems for residential PV systems raises concerns about environmental pollution that may result from a wider diffusion of batteries.

Lead-acid batteries contain sulfuric acid as well as toxic lead and generate carbon emissions particularly during lead mining and polypropylene production [54, 55]. This environmental impact of lead-acid batteries can be significantly reduced when recycling the lead. Yet, while in Germany nearly 100% of the lead in commercial-scale lead-acid batteries is recycled [40], the use of batteries is more problematic in countries which do not yet possess a working recycling infrastructure. An additional challenge lies in producing battery systems that allow operation without safety threats from short circuits, deep discharge, over-discharge and over-temperature [56]. Preventing the occurrence of such threats will require mandatory safety tests and certification procedures for the producers of battery systems. Moreover, a maintenance infrastructure will have to be set up that ensures the reliable operation and timely replacement of batteries.

5.3 Implications for the Electricity Sector

Besides providing insights into potential changes in household investments, our analysis has important implications for the electricity sector. As discussed in section 4.1, it can be expected that even without policy support households will raise the amount of electricity they produce themselves. The use of battery storage supports this trend as it allows households to consume a larger share of self-produced electricity, reducing the amount of electricity to be bought from utilities. Moreover, if households are also able to sell their electricity on the wholesale market in the future, an ever increasing number of households will move from being electricity consumers to becoming net electricity producers. This trend has the potential of fundamentally altering the existing market structure. Electric utilities are likely to be confronted with a growing number of households that produce and sell their own electricity which fundamentally undermines their current business model. At the same time, a shift toward a system of strongly distributed electricity generation will probably require major adaptations in the technical infrastructure of the electricity system, such as distribution grids. In fact, the observation that storage is economically viable for a private household does not imply that implementing battery storage systems is also beneficial from the perspective of overall stability of the electricity system. It currently remains open to what degree implementing small-scale, distributed storage reduces throughput and required capacity of the electricity grid. Hollinger et al. [57] find that battery storage for residential PV systems can reduce the burden on the electricity distribution grids by around 40 percent. In contrast, Büdenbender et al. [58] find no positive effect of storage on alleviating the stress on the distribution grid that is created by distributed PV. Some authors even argue that instead of enhancing grid stability, small-scale storage may add to instabilities [30]. It is suggested that, if storage solutions implemented are small, electricity feed-in patterns of PV systems could become less predictable with irregular peaks in distribution grids occurring when storages are loaded before noon.

5.4 Implications for Policy Makers

Finally, our results allow drawing some conclusions for policy makers. First, we find that residential PV systems of small sizes (with and without storage) are profitable without policy support under almost all scenarios in Germany in 2013. Nevertheless, policy support, e.g. in the form of feed-in tariffs may be necessary for at least an intermediary period since in an environment without policy support a) the PV systems that are built tend to be rather small, leading to a suboptimal use of roof-space and b) uncertainties and the inability of households to determine the profitability of PV systems may prevent households from investing (see section 5.1).

Second, the findings of our analysis imply that additional economic incentives to foster the use of small scale storage in combination with residential PV systems in Germany appear necessary only in the short term. This result is of importance since several institutions in Germany, such as the German Solar Photovoltaic Industry Association (BSW), have called for additional incentives for battery storage in the past [30]. Recently, the German government has responded to this call by announcing a 50 million EUR demonstration program that provides investment subsidies to buyers of storage for residential PV system [5]. Our findings indicate that the incentives provided under this program can be phased out relatively soon as rising electricity retail prices and falling technology costs raise the profitability of storage.

Third, our findings allow us to derive some insights into how different political interventions affect the economic viability of storage. In essence, all political measures that raise the retail price can be expected to also raise the profitability of storage investments for residential PV in the short-term. In the longer-term, measures that lower the wholesale price can additionally contribute to increasing the NPV from storage investments. In this sense, electricity taxes and grid fees that are only included in retail and not wholesale prices will provide an incentive for households to invest in storage technologies. Premiums for self-consumption will generally raise the profitability of storage investments. From the sensitivity analysis, it can further be derived that measures which reduce the investment cost of PV and storage, such as deployment policies or investments in R&D, contribute to enhanced storage profitability. Moreover, an important means for raising the profitability of investments in storage lies in lowering the interest rate at which households can obtain capital at financial markets. In this sense, low-interest loan programs, such as the KfW program in Germany, are likely to be very effective means at fostering storage investments.¹² For measures like feed-in premiums, the effect on storage profitability is less clear since, on the one hand, they raise the price at which households can sell the electricity on the market (negative effect on storage profitability). On the other hand, however, feed-in premiums increase the deployment of PV, potentially reduce

¹² Currently, the low-interest loans from the KfW bank are only available for PV systems. However, there are plans to introduce specific loan programs for storage which according to our analysis appears an effective way of fostering storage investments.

wholesale prices in the longer term and may raise the retail prices in the short-term (positive effect on storage profitability – see section 3.3). In Germany, FIT premiums have fallen significantly in the recent past while, simultaneously, the increasing use of renewables has raised retail and lowered wholesale prices. Interestingly, therefore, in Germany the policy-induced deployment of PV itself has driven the profitability of storage as a complementary technology.

6 Limitations and Future Research

Our study has several limitations that lend themselves as avenues for future research. First, as for any model, our results are limited by the input parameters chosen for our simulation. To keep the scope of the paper within reasonable boundaries, we restricted the choice of technologies to one PV and one battery technology. As described in section 3, strong research and development efforts that are currently being undertaken on other battery types (e.g., lithium-ion or sodium sulfur) could lead to significant cost decreases in the next years which would warrant a closer investigation of these technologies in residential PV applications. Moreover, assuming cost decreases in PV to follow the pattern of learning curves, of course, paints a simplified picture of technological change. While for our model the accuracy reached using learning curves is probably sufficient, a more detailed model of technological change would have to consider a wider range of drivers of technological change than deployment [59] and should also take into consideration the rate at which technologies are deployed [60]. Since investment costs for technology, solar irradiation, electricity prices and electricity consumption patterns differ between countries [61], it would be valuable to repeat our analysis for households in other geographic locations. Furthermore, in future studies different household characteristics, such as the number of persons living in the household, should be varied to provide a more comprehensive picture of the economic viability of storage under different conditions. Ideally, when doing so, the resolution of the data regarding both, electricity generation and consumption, should be enhanced to account for short-term peaks that are leveled out when using hourly data. Although Wille-Haussmann et al. [62] find that changing the resolution from 10s to 15 min values alters the self-consumption ratio only by 2 to 3%, a higher resolution becomes important when conducting a more detailed analysis of storage use for specific days, e.g. least or most sunny days during the year.

Second, we restrict our economic analysis to investigating how storage can be used to leverage the existing price spread between wholesale and retail prices. Beyond increasing self-consumption, however, storage can generate economic value in a range of different applications, such as ancillary services or arbitrage dealing, e.g. buying electricity at night and reselling it to the grid at daytime when electricity prices tend to be higher [13]. Combining different applications can potentially further increase the economic viability of storage compared to the findings in this paper [63]. In this context,

it should be kept in mind that in our model we assume the electricity consumption of the household to be invariant to electricity prices. It seems likely that in reality, especially with the emergence of demand-side management systems, households may alter their consumption pattern depending on the prices they face.

7 Conclusion

In this paper we investigate when and under which conditions battery storage will be economically viable in residential PV systems without policy support. Building upon a review of previous studies on the economics of battery storage for distributed PV, we develop a techno-economic model that simulates the profitability of battery storage from 2013 to 2022 under eight different scenarios for PV investment costs and electricity prices in Germany. In contrast to previous forward-looking studies, we assume that no feed-in or self-consumption premium is paid for electricity generated using solar PV. Moreover, for each year of investment and each scenario, our model tests more than 1,400 combinations of PV system and storage size to determine the one that yields the highest net present value. We find that, given an economically rational household, investments in battery storage are already profitable for small residential PV systems. The optimal PV system and storage sizes rise significantly over time such that in our model households become net electricity producers between 2015 and 2021 if they are provided access to the electricity wholesale market. Developments that lead to an increase in retail or a decrease in wholesale prices further contribute to the economic viability of storage. Under a scenario where households are not allowed to sell excess electricity on the wholesale market, the economic viability of storage for residential PV is particularly high. Our findings have important implications for the electricity sector and regulators that wish to shape its future. We conclude that, under the assumptions of our model additional policy incentives to foster investments in battery storage for residential PV in Germany seem necessary only in the short-term. At the same time, the increasing profitability of integrated PV-storage-systems may come with major challenges for electric utilities and is likely to require increased investments in technical infrastructure that supports the ongoing trend toward distributed electricity generation.

Acknowledgements

The authors would like to thank Laura Diaz Anadon, Joern Huenteler and Michael Peters for their valuable comments on earlier drafts of this article. Moreover, we would like to acknowledge the helpful feedback we received by two anonymous reviewers.

References

- [1] Nitsch J. Technologische und energiewirtschaftliche Perspektiven erneuerbarer Energien. Stuttgart, Germany: Deutsches Zentrum für Luft- und Raumfahrt (DLR); 2007.
- [2] Joshi AS, Dincer I, Reddy BV. Performance Analysis of Photovoltaic Systems: A Review. *Renewable and Sustainable Energy Reviews*. 2009;13:1884-97.
- [3] Eltawil MA, Zhao Z. Grid-Connected Photovoltaic Power Systems: Technical and Potential Problems - A Review. *Renewable and Sustainable Energy Reviews*. 2010;14:112-29.
- [4] Krause MB. Zwei Wege, ein Ziel - Solon und Schüco verkaufen ab Anfang kommenden Jahres auch Speichersysteme für Solaranlagen. *Photon*. 2011;12:51f.
- [5] Photon. BSW-Solar begrüsst staatliche Förderung von Solarstromspeichern. Accessed online 24/01/2013: <http://www.photon-international.com/newsletter/document/73209pdf>.
- [6] Bost M, Hirschl B, Aretz A. Effekte von Eigenverbrauch und Netzparität bei der Photovoltaik. Studie im Auftrag von Greenpeace Energy eG. Berlin: Institut für ökologische Wirtschaftsforschung (IÖW); 2011.
- [7] Braun M, Büdenbender K, Magnor D, Jossen A. Photovoltaic Self-Consumption in Germany Using Lithium-Ion Storage to Increase Self-Consumed Photovoltaic Energy. Kassel: ISET; 2009.
- [8] Colmenar-Santos A, Campiñez-Romero S, Pérez-Molina C, Castro-Gil M. Profitability Analysis of Grid-Connected Photovoltaic Facilities for Household Electricity Self-Sufficiency. *Energy Policy*. 2012;51:749-64.
- [9] Hoppmann J, Huenteler J, Girod B. Compulsive Policy-Making - The Evolution of the German Feed-in Tariff for Solar Photovoltaic Power. *Research Policy*. 2014;in press.
- [10] Arun P, Banerjee R, Bandyopadhyay S. Optimum Sizing of Photovoltaic Battery Systems Incorporating Uncertainty through Design Space Approach. *Solar Energy*. 2009;83:1013-25.
- [11] Askari IB, Ameri M. Optimal Sizing of Photovoltaic-Battery Power Systems in a Remote Region in Kerman, Iran. *Proceedings of the Institution of Mechanical Engineers, Part A: Journal of Power and Energy*. 2009;223:563-70.
- [12] Avril S, Arnaud G, Florentin A, Vinard M. Multi-Objective Optimization of Batteries and Hydrogen Storage Technologies for Remote Photovoltaic Systems. *Energy*. 2010;35:5300-8.
- [13] Battke B, Schmidt TS, Grosspietsch D, Hoffmann VH. A review and probabilistic model of lifecycle costs of stationary batteries in multiple applications. *Renewable and Sustainable Energy Reviews*. 2013;25:240-50.
- [14] Celik A, Muneer T, Clarke P. Optimal Sizing and Life Cycle Assessment of Residential Photovoltaic Energy Systems with Battery Storage. *Progress in Photovoltaics: Research and Applications*. 2008;16:69-85.
- [15] Clastres C, Ha Pham T, Wurtz F, Bacha S. Ancillary Services and Optimal Household Energy Management with Photovoltaic Production. *Energy*. 2010;35:55-64.

- [16] Denholm P, Margolis RM. Evaluating the Limits of Solar Photovoltaics (PV) in Electric Power Systems Utilizing Energy Storage and other Enabling Technologies. *Energy Policy*. 2007;35:4424-33.
- [17] Jallouli R, Krichen L. Sizing, Techno-Economic and Generation Management Analysis of a Stand Alone Photovoltaic Power Unit Including Storage Devices. *Energy*. 2012;40:196-209.
- [18] Kaldellis J, Zafirakis D, Kaldelli E, Kavadias K. Cost Benefit Analysis of a Photovoltaic-Energy Storage Electrification Solution for Remote Islands. *Renewable Energy*. 2009;34:1299-311.
- [19] Kolhe M. Techno-Economic Optimum Sizing of a Stand-Alone Solar Photovoltaic System. *IEEE Transactions on Energy Conversion*. 2009;24:511-9.
- [20] Kolhe M, Kolhe S, Joshi J. Economic Viability of Stand-Alone Solar Photovoltaic System in Comparison with Diesel-Powered System for India. *Energy Economics*. 2002;24:155-65.
- [21] Lazou AA, Papatsoris AD. The Economics of Photovoltaic Stand-Alone Residential Households: A Case Study for Various European and Mediterranean Locations. *Solar Energy Materials and Solar Cells*. 2000;62:411-27.
- [22] Li CH, Zhu XJ, Cao GY, Sui S, Hu MR. Dynamic Modeling and Sizing Optimization of Stand-Alone Photovoltaic Power Systems Using Hybrid Energy Storage Technology. *Renewable Energy*. 2009;34:815-26.
- [23] Liu G, Rasul M, Amanullah M, Khan M. Techno-Economic Simulation and Optimization of Residential Grid-Connected PV System for the Queensland Climate. *Renewable Energy*. 2012;45:146-55.
- [24] Wissem Z, Gueorgui K, Hédi K. Modeling and Technical-Economic Optimization of an Autonomous Photovoltaic System. *Energy*. 2012;37:263-72.
- [25] Parida B, Iniyani S, Goic R. A Review of Solar Photovoltaic Technologies. *Renewable and Sustainable Energy Reviews*. 2011;15:1625-36.
- [26] Peters M, Schmidt TS, Wiederkehr D, Schneider M. Shedding Light on Solar Technologies - A Techno-Economic Assessment and its Policy Implications. *Energy Policy*. 2011;39:6422-39.
- [27] Kazmerski LL. Photovoltaics: A Review of Cell and Module Technologies. *Renewable and Sustainable Energy Reviews*. 1997;1:71-170.
- [28] Hadjipaschalis I, Poullikkas A, Efthimiou V. Overview of Current and Future Energy Storage Technologies for Electric Power Applications. *Renewable and Sustainable Energy Reviews*. 2009;13:1513-22.
- [29] Divya K, Østergaard J. Battery Energy Storage Technology for Power Systems - An Overview. *Electric Power Systems Research*. 2009;79:511-20.
- [30] Sauer DU, Leuthold M, Magnor D, Lunz B. Dezentrale Energiespeicherung zur Steigerung des Eigenverbrauchs bei netzgekoppelten PV-Anlagen - Studie im Auftrag des Bundesverbands Solarwirtschaft (BSW). Aachen: Institut für Stromrichtertechnik und Elektrische Antriebe, RWTH Aachen; 2011.

- [31] EPIA. Global Market Outlook for Photovoltaics until 2016. Brussels: European Photovoltaic Industry Association; 2012.
- [32] Bundesnetzagentur. Stammdaten zu PV-Anlagen. Accessed online 10/07/2012:
http://www.bundesnetzagentur.de/cln_1912/DE/Sachgebiete/ElektrizitaetGas/ErneuerbareEnergienGesetz/VerguetungssaetzePVAnlagen/VerguetungssaetzePhotovoltaik_Basepagehtml. Berlin.
- [33] Jenkins D, Fletcher J, Kane D. Model for Evaluating Impact of Battery Storage on Microgeneration Systems in Dwellings. *Energy Conversion and Management*. 2008;49:2413-24.
- [34] Castillo-Cagigal M, Caamaño-Martín E, Matallanas E, Masa-Bote D, Gutiérrez A, Monasterio-Huelin F, et al. PV Self-Consumption Optimization with Storage and Active DSM for the Residential Sector. *Solar Energy*. 2011;85:2338-48.
- [35] U.S. Department of Energy. EnergyPlus: Weather Data. Accessed online 10/01/2012:
http://apps1.eere.energy.gov/buildings/energyplus/cfm/weather_data.cfm.
- [36] Photon. Das Jahr des Drachen - Photovoltaik Weltmarkt 2011. Photon. 2012;2012:38-71.
- [37] Reich NH, Mueller B, Armbruster A, Sark WG, Kiefer K, Reise C. Performance Ratio Revisited: Is PR > 90% Realistic? *Progress in Photovoltaics: Research and Applications*. 2012;20:717-26.
- [38] Jordan DC, Smith R, Osterwald C, Gelak E, Kurtz SR. Outdoor PV Degradation Comparison. 35th IEEE Photovoltaics Specialists Conference: Honolulu, Hawaii: 20-25 June 2010. 2010.
- [39] Nair NKC, Garimella N. Battery Energy Storage Systems: Assessment for Small-Scale Renewable Energy Integration. *Energy and Buildings*. 2010;42:2124-30.
- [40] VDE. Energiespeicher in Stromversorgungssystemen mit hohem Anteil erneuerbarer Energieträger - Bedeutung, Stand der Technik, Handlungsbedarf. Frankfurt, Germany: Energietechnische Gesellschaft im VDE; 2009.
- [41] E.ON Bayern. BDWE Standardlastprofile (SLP) H0 (Haushalte). Accessed online 10/10/2011:
http://www.eon-bayern.com/pages/eby_de/Netz/Stromnetz/Netzzugang/Lastprofilverfahren/Standard_Lastprofile/indexhtml.
- [42] eurostat. Harmonized Indices of Consumer Prices (HICP). Accessed online 02/07/2013:
<http://eppeurostate.europa.eu/portal/page/portal/hicp/data/database>.
- [43] EPIA. Global Market Outlook for Photovoltaics until 2018. Brussels: European Photovoltaic Industry Association; 2014.
- [44] pvXchange. Modulpreise für Photovoltaik Anlagen. Accessed online 04/08/2014:
<http://www.solaranlagen-portal.com/solar/solaranlage/preise/modulpreise>.
- [45] Kost C, Schlegl T. Studie Stromerzeugungskosten Erneuerbare Energien. Fraunhofer ISE, Freiburg. 2010.
- [46] Wand R, Leuthold F. Feed-in Tariffs for Photovoltaics: Learning by Doing in Germany? *Applied Energy*. 2011;88:4387-99.

- [47] Junginger M, van Sark W, Faaij A. Technological Learning in the Energy Sector - Lessons for Policy, Industry and Science. Cheltenham, UK: Edward Elgar; 2010.
- [48] EPIA. Solar Photovoltaics - Competing in the Energy Sector. Brussels: European Photovoltaic Industry Association; 2011.
- [49] BSW Solar. Statistische Zahlen der deutschen Solarstrombranche (Photovoltaik). Berlin, Germany: Bundesverband Solarwirtschaft; 2014.
- [50] Schaeffer GJ, Seebregts AJ, Beurskens LWM, Moor HHCd, Alsema EA, van Sark WGHM, et al. Learning from the Sun; Analysis of the use of experience curves for energy policy purposes: The case of photovoltaic power. Final report of the Photex project. Petten: ECN Energy in the Built Environment; 2004.
- [51] BDEW. BDEW-Strompreisanalyse November 2013. Berlin: Bundesverband der Energie- und Wasserwirtschaft; 2013.
- [52] Lödl M, Kerber G, Witzmann R, Hofmann C, Metzger M. Abschätzung des Photovoltaik-Potentials auf Dachflächen in Deutschland. 11 Symposium Energieinnovation, February 2010, Graz, Austria 2010. p. 2010.
- [53] Itten R, Wyss F, Frischknecht R. LCI of the global crystalline photovoltaics supply chain and of future photovoltaics electricity production. Uster: Swiss Federal Office of Energy; 2014.
- [54] Rydh CJ. Environmental assessment of vanadium redox and lead-acid batteries for stationary energy storage. Journal of power sources. 1999;80:21-9.
- [55] McManus MC. Environmental consequences of the use of batteries in low carbon systems: The impact of battery production. Applied Energy. 2012;93:288-95.
- [56] Rand D, Moseley PT, Garche J, Parker C. Valve-regulated lead-acid batteries. Amsterdam: Elsevier; 2004.
- [57] Hollinger R, Wille-Hausmann B, Erge T, Sönnichsen J, Stillahn T, Kreifels N. Speicherstudie 2013 - Kurzgutachten zur Abschätzung und Einordnung energiewirtschaftlicher, ökonomischer und anderer Effekte bei Förderung von objektgebunden elektrochemischen Speichern. Freiburg: Fraunhofer Institut für Solare Energiesysteme ISE; 2013.
- [58] Büdenbender K, Braun M, Schmiegel A, Magnor D, Marcel JC. Improving PV-Integration into the Distribution Grid - Contribution of Multifunctional PV-Battery Systems to Stabilised System Operation. Kassel: ISET; 2010. p. 7.
- [59] Nemet GF. Beyond the Learning Curve: Factors Influencing Cost Reductions in Photovoltaics. Energy Policy. 2006;34:3218-32.
- [60] Hoppmann J, Peters M, Schneider M, Hoffmann VH. The two faces of market support - How deployment policies affect technological exploration and exploitation in the solar photovoltaic industry. Research Policy. 2013;42:989-1003.
- [61] Schmidt TS, Born R, Schneider M. Assessing the Costs of Photovoltaic and Wind Power in Six Developing Countries. Nature Climate Change. 2012;2:548-53.

- [62] Wille-Haussmann B, Link J, Sabo A, Wittwer C. Photovoltaik Eigenstromnutzung - Fluktuation von Strahlung und Last. 27 Symposium Photovoltaische Solarenergie. Bad Staffelstein 2012.
- [63] Braun M, Stetz T. Multifunctional Photovoltaic Inverters - Economic Potential of Grid-Connected Multifunctional PV-Battery-Systems in Industrial Environments. 23rd European Photovoltaic Solar Energy Conference, 1-5 September 2008, Valencia, Spain 2008.
- [64] Burke A, Jungers B, Yang C, Ogden J. Battery Electric Vehicles: An Assessment of the Technology and Factors Influencing Market Readiness. Advanced Energy Pathways (AEP) Project, UC Davis, Institute of Transportation Studies. Davis, CA 2007.
- [65] Chen H, Cong TN, Yang W, Tan C, Li Y, Ding Y. Progress in Electrical Energy Storage System: A Critical Review. Progress in Natural Science. 2009;19:291-312.
- [66] Dunn B, Kamath H, Tarascon JM. Electrical Energy Storage for the Grid: A Battery of Choices. Science. 2011;334:928-35.
- [67] EPRI, US DOE. EPRI-DOE Handbook of Energy Storage for Transmission & Distribution Applications. Washington, DC: EPRI and the U.S. Department of Energy; 2003.
- [68] Gonzalez A, Gallachóir BO, McKeogh E, Lynch K. Study of Electricity Storage Technologies and their Potential to Address Wind Energy Intermittency. A study for the Sustainable Energy Ireland Program. University College Cork, Cork.; 2004.
- [69] Schoenung S, Hassenzahl WV. Long- vs. Short-Term Energy Storage Technologies Analysis - A Life-Cycle Cost Study. Sandia National Laboratories, Albuquerque, New Mexico; 2003.
- [70] Wu K, Kato T, Yokomizu Y, Okamoto T, Goto M, Suzuoki Y. Economic Value of the Inverter in Residence-Use PV System Applied for Electricity Storage at Night. IEEE Power Engineering Society Winter Meeting 2002. p. 195-8.
- [71] BMU. Erfahrungsbericht 2007 zum Erneuerbare-Energien-Gesetz (EEG-Erfahrungsbericht). Berlin: Bundesministerium für Umwelt, Naturschutz und Reaktorsicherheit; 2007.
- [72] Branker K, Pathak M, Pearce J. A Review of Solar Photovoltaic Levelized Cost of Electricity. Renewable and Sustainable Energy Reviews. 2011;15:4470-82.
- [73] Bhandari R, Stadler I. Grid Parity Analysis of Solar Photovoltaic Systems in Germany Using Experience Curves. Solar Energy. 2009;83:1634-44.
- [74] van der Zwaan B, Rabl A. Prospects for PV: A Learning Curve Analysis. Solar Energy. 2003;74:19-31.
- [75] Roland Berger, Prognos. Wegweiser Solarwirtschaft: PV Roadmap 2020. München 2010.
- [76] Nitsch J, Pregarer T, Scholz Y, Naegler T, Sterner M, Gerhardt N, et al. Langfristszenarien und Strategien für den Ausbau der erneuerbaren Energien in Deutschland bei Berücksichtigung der Entwicklung in Europa und global - Leitstudie 2010. Deutsches Zentrum für Luft- und Raumfahrt (DLR), Stuttgart Institut für Technische Thermodynamik, Abt. Systemanalyse und Technikbewertung, Fraunhofer Institut für Windenergie und Energiesystemtechnik (IWES), Kassel, Ingenieurbüro für neue Energien (IFNE), Teltow; 2010.

[77] Nagl S, Fürsch M, Paulus M, Richter J, Trüby J, Lindenberger D. Scenarios for an Energy Policy Concept of the German Government. Institute of Energy Economics, University of Cologne, Köln; 2010.

Appendix A

Table A.1: Overview of lead-acid technology parameters in the literature

Author (year)	Self-discharge [% per day]	Roundcycle efficiency [%]
Burke et al. [64]	0.3	
Chen et al. [65]	0.1-0.3	70-90
Divya and Østergaard [29]	0.06-0.17	72-78
Dunn et al. [66]		75-90
EPRI and DOE [67]	0.033	75-85
Gonzalez et al. [68]		81
Hadjipaschalis et al. [28]	2	85-90
Sauer et al. [30]		80-90
Schoenung and Hassenzahl [69]	0.1	70-80
VDE [40]		80-90
Wu et al. [70]		80

Cumulative global installed PV capacity [GW]

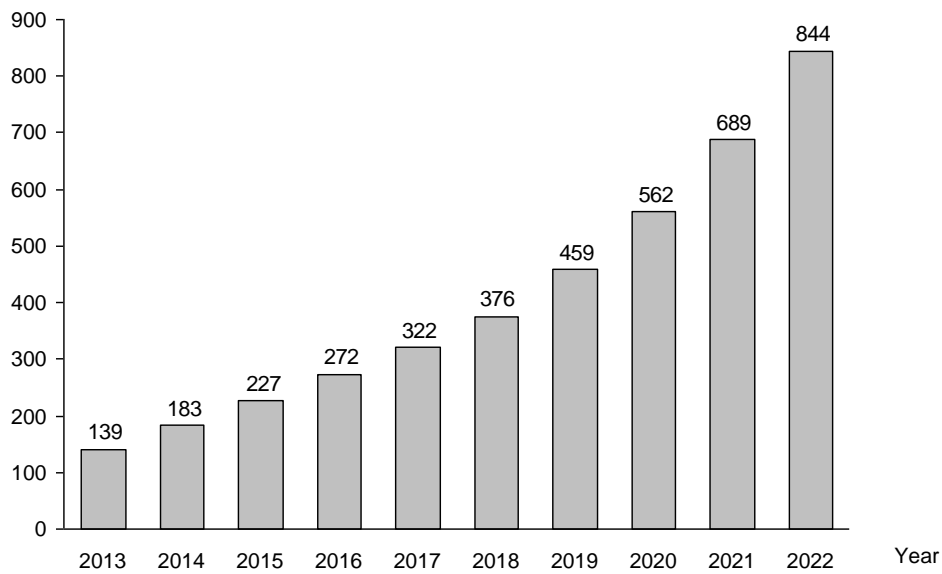

Figure A.1: Global PV deployment underlying the PV investment cost development

Table A.2: Overview of interest rates in the literature

Author (year)	Interest Rates
BMU [71]	5-8%
Branker et al. [72]	4.5%
Bost et al. [6]	0%

Table A.3: Overview of module lifetime parameters in the literature

Author (year)	Module lifetime [years]
Bhandari and Stadler [73]	25-40
Denholm and Margolis [16]	30
EPIA [48]	25-35
Sauer et al. [30]	20
Van der Zwaan and Rabl [74]	25

Table A.4: Overview of electricity price forecasts for Germany in the literature

Author (year)	CAGR retail price	CAGR wholesale price
Bhandari and Stadler [73]	2 - 4%	3 - 6%
EPIA [48]	0.9%	4%
Roland Berger and Prognos [75]	1.7%	3.2 - 5.1%
Nitsch et al. [76]		0 - 2.5%
Nagl et al. [77]	0 - 0.4%	

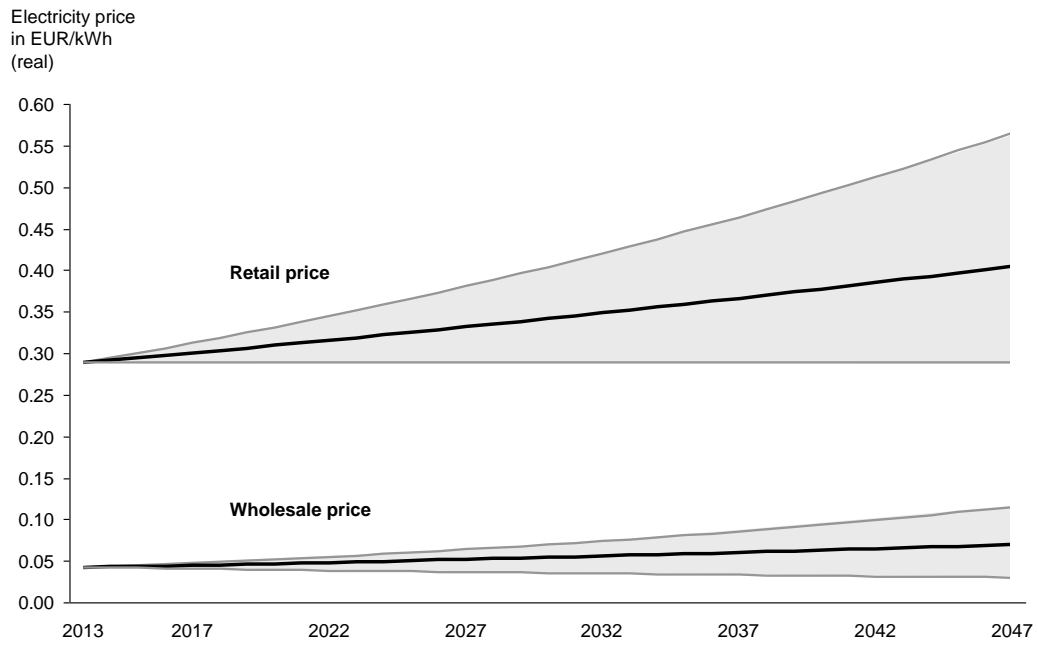

Figure A.2: Assumed electricity price developments

Appendix B

The net present value of the integrated PV system is calculated as

$$NPV_t = -C_t + \sum_{n=0}^N \frac{C_{IN,t,n} - C_{OUT,t,n}}{(1+i)^n}$$

where

$$C_t = CAPEX_{PV,t} + CAPEX_{BAT,t} + \frac{CAPEX_{BAT,t+9}}{(1+i)^9}$$

$$C_{IN,t,n} = [SCR_t \cdot RP_n + (1 - SCR_t) \cdot WP_n] \cdot kWh_t * (1 - DR)^n$$

$$C_{OUT,t,n} = OPEX_{PV,t,n} + OPEX_{BAT,t,n}$$

and

NPV:	Net present value of integrated PV-storage system
t:	Year of investment (2011, ..., 2020)
n:	Year of system lifetime (0, ..., 25)
N:	System lifetime (25 years)
i:	Interest rate (4%)
C_{IN} :	Cash flow in
C_{OUT} :	Cash flow out
SCR:	Self-consumption ratio
RP:	Retail price
WP:	Wholesale price
kWh:	Electricity generated by PV system
DR:	Module degradation rate
$CAPEX_{PV}$	Capital investment cost PV system
$CAPEX_{BAT}$	Capital investment cost battery system
$OPEX_{PV}$	Operations and maintenance cost PV system
$OPEX_{BAT}$	Operations and maintenance cost battery system

Appendix C

To find the optimal configuration of the integrated PV-storage system, the module inputs different storage and PV system sizes into the “Self-Consumption Calculation Module”. Based on the calculated self-consumption ratio then the NPV is retrieved from the “Net Present Value Calculation Module” and entered into a matrix that is specific to the scenario. In this manner, a total of 100 matrices (10 matrices per investment year) are constructed. As an example, Figure C.1 shows the matrix that contains the net present value as a function of PV system and storage size for the investment year 2015 under scenario S3 (medium electricity retail and medium electricity wholesale price increases).

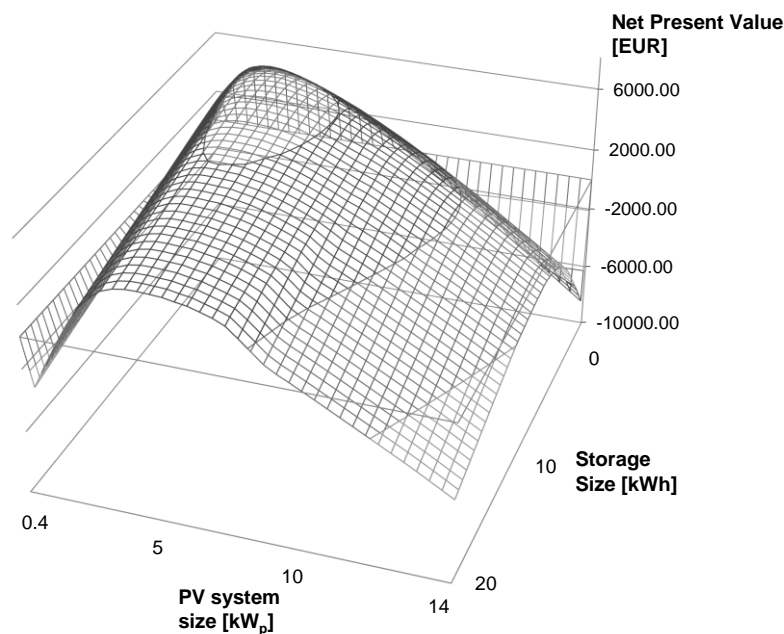

Figure C.1: Net present value as a function of storage and PV system size for electricity price scenario S3 in 2017 (exemplary)

After constructing the matrix for a specific investment year and scenario, a grid search algorithm was used to determine that combination of PV system and storage size which yields the highest overall net present value for the integrated PV-battery system. This value was then compared to the highest NPV achievable without storage to determine the economic value of adding storage to the PV system. In Figure C.1, for example, the highest NPV (7,022 EUR) can be achieved at a PV system size of 4 kW_p and a storage size of 5.5 kWh. The highest achievable NPV without storage is 4,580 EUR for a PV system size of 2.4 kW_p, leading to an additional NPV due to storage of 2,442 EUR.